

LINEAR PANNEAUX MURAUX LINEAR | WALL PANELS

La base du système LINEAR est un profilé fin en aluminium, à encastrer dans un panneau bois ou acrylique. Divers éléments d'équipement peuvent être insérés le long du profilé et positionnés selon vos souhaits. Comme avec tous les systèmes d'agencement de concept-s, l'agencement rapide et sans problème est rendu possible, de telle sorte que votre présentation de produits reste toujours modifiable.

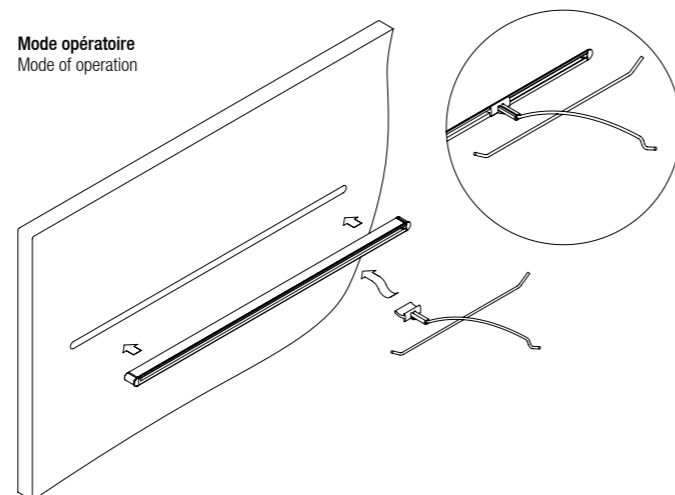



The basis of the LINEAR system is a simple speed frame, which is embedded horizontally into a wooden or acrylic glass panel. Along the profile, different kinds of fitting elements can be positioned flexibly on the display area. As you are used to other shop design systems by concept-s, your wall display can be redecorated quickly and effortlessly so that your merchandise display can be designed newly again and again.

Mode opératoire
Mode of operation



Panneaux en acrylique, blanc mat, équipés avec LINEAR System et supports lunettes. Inclus structure MOSAIC.* Autres accessoires disponibles, veuillez commander séparément. Autres variantes disponibles sur demande.

Panels made of acrylic glass, matt white, fitted with LINEAR system and single spectacle displays. *MOSAIC substructure included.* Additional accessories available, please order separately. Additional variants available on request.

01 MO W 70/14 LINEAR 695 x 1395 mm MO.01.01.70.14.04	 36 651,00 €
02 MO W 87/14 LINEAR 870 x 1395 mm MO.01.01.87.14.04	 48 827,00 €
03 MO W 70/21 LINEAR 695 x 2095 mm MO.01.01.70.21.04	 45 885,00 €
04 MO W 87/21 LINEAR 870 x 2095 mm MO.01.01.87.21.04	 60 1.121,00 €

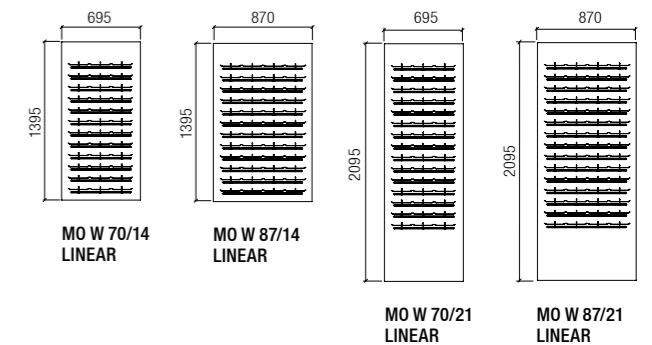

! * Pour une installation plus facile, nous recommandons les plaques de montage (référence article MO.00.00.00.02: 77,00 € par m²) et les couvercle latéral (référence article MO.00.00.00.01: 28,00 € par m). Veuillez commander séparément!
* For easier installation we recommend mounting plates (item no. MO.00.00.00.02: 77,00 Euro per m²) and lateral covers (item no. MO.00.00.00.01: 28,00 Euro per m). Please order separately!

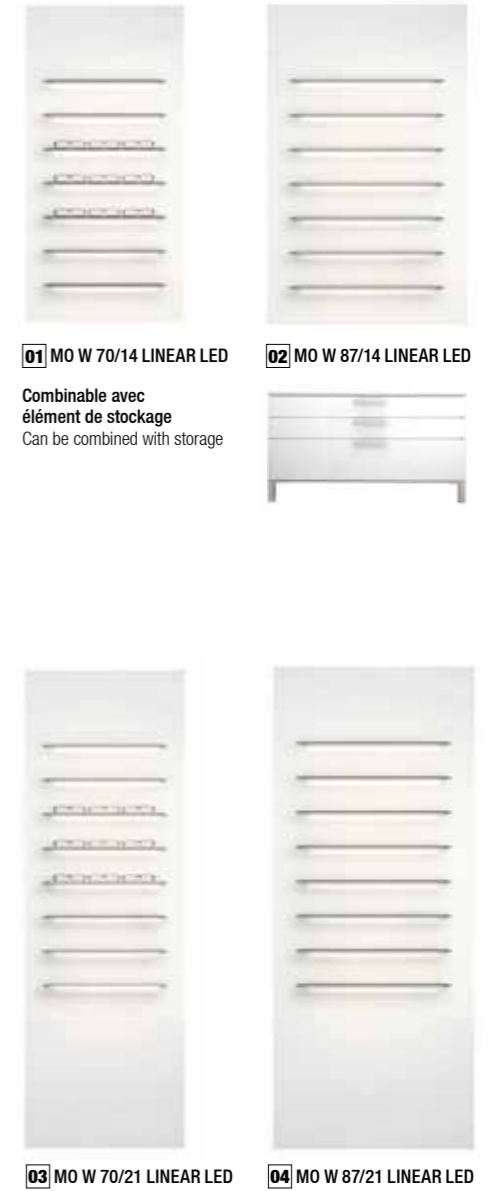

LINEAR LED PANNEAUX MURAUX WALL PANELS

Les tablettes LINEAR LED sont d'un design élégant et d'un positionnement réduit avec un chant éclairé visible en partie frontale. De plus, elles sont équipées d'un éclairage LED en partie inférieure qui éclaire les produits placés en dessous et les met parfaitement en valeur. Des aimants invisibles intégrés dans la tablette permettent un placement libre et ordonné des supports adaptés pour lunettes, vous donnant ainsi la possibilité d'une présentation répondant à vos souhaits.



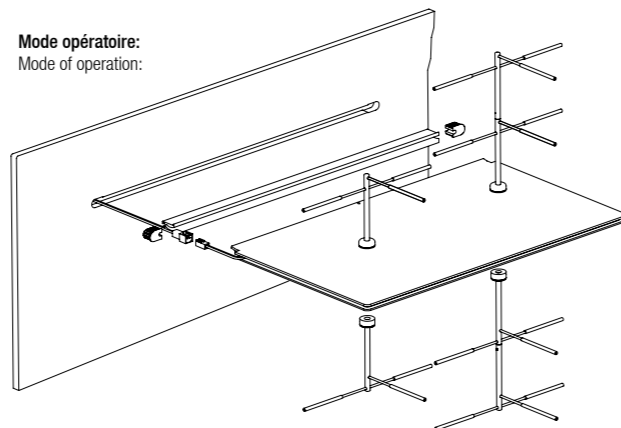

The LINEAR LED shelves have elegant design and low installation height with visible light at the front edge. They also have a built-in LED light at the bottom which also illuminates underlying objects perfectly and brings to bear. In the shelves invisible magnets are embedded, which allows the flexible and orderly positioning of matching spectacle displays and thus provides a clear presentation.

Mode opératoire:
Mode of operation:



Panneaux en acrylique, blanc mat, équipés avec le LINEAR système et tablettes LINEAR LED. Inclus structure MOSAIC.* Autres accessoires disponibles, veuillez commander séparément. Autres variantes disponibles sur demande.

Panels made of acrylic glass, matt white, fitted with LINEAR system and LINEAR LED shelves. MOSAIC substructure included.* Additional accessories available, please order separately. Additional variants available on request.

- | | |
|---|--|
| 01 MO W 70/14 LINEAR LED
695 x 1395 mm
MO.05.01.70.14.04 |  21
1.405,00 € |
| 02 MO W 87/14 LINEAR LED
870 x 1395 mm
MO.05.01.87.14.04 |  28
1.646,00 € |
| 03 MO W 70/21 LINEAR LED
695 x 2095 mm
MO.05.01.70.21.04 |  24
1.717,00 € |
| 04 MO W 87/21 LINEAR LED
870 x 2095 mm
MO.05.01.87.21.04 |  32
2.019,00 € |

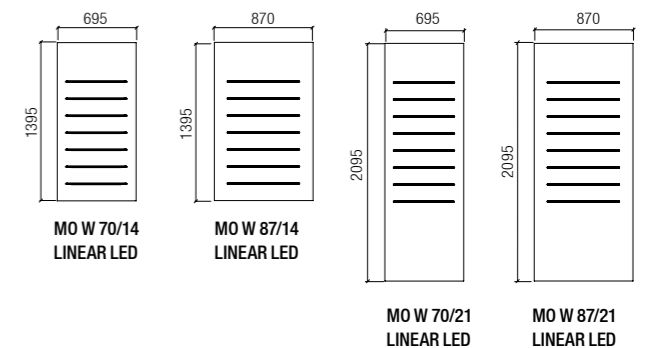

COMPOSANTS DE SYSTÈMES
SYSTEM COMPONENTS

01
Profilé LINEAR, aluminium, au mètre
LINEAR profile, aluminium, sold by metre

max. 6000 x 9 x 14 mm

A. pour panneau bois
for wooden panels L/13.01.10.06 **8,00 €**

B. pour panneau acrylique
for acrylic glass panels L/13.01.11.06 **16,00 €**



02
Embout, paire, pour profilé LINEAR
End cap, one pair, for LINEAR profile

pour panneau bois
for wooden panels L/13.01.11.07 **2,00 €**

pour panneau acrylique
for acrylic glass panels L/13.01.11.08 **2,00 €**



03
Passage de câble pour profilé LINEAR, paire
Cable outlet for LINEAR profile, one pair

pour panneau bois
for wooden panels L/13.01.20.00 **5,00 €**

pour panneau acrylique
for acrylic glass panels L/13.01.20.01 **5,00 €**



* Note: Les dimensions des rails sont soumises à des tolérances. Veuillez fraiser la rainure uniquement si vous avez le rail d'origine.
* Note: The dimensions of the rail are subjected to tolerances. Please only mill the groove when the original rail is available to you!

04
Support lunettes LINEAR, nickelé
LINEAR single spectacle display, nickel-plated

180 x 75 x 182 mm L/14.09.00.02 **6,00 €**



05
Support étui LINEAR en fil, nickelé
LINEAR spectacle case display, nickel-plated

83 x 36 x 132 mm L/19.11.30.02 **6,00 €**



06
Plaque logo LINEAR pour logos interchangeables
LINEAR signboard for exchangeable logos

150 x 70 x 48 mm L/14.18.01.03 **25,00 €**



07
Étagère en métal LINEAR, en aluminium, époxy blanc
Metal shelf, made of aluminium, white powder-coated

Taille S Size S
350 x 2 x 200 mm L/14.18.40.00 **32,00 €**

Taille M Size M
500 x 2 x 200 mm L/14.18.50.00 **38,00 €**

Taille L Size L
600 x 2 x 200 mm L/14.18.60.00 **43,00 €**

Taille XL Size XL
825 x 2 x 200 mm L/14.18.80.00 **52,00 €**

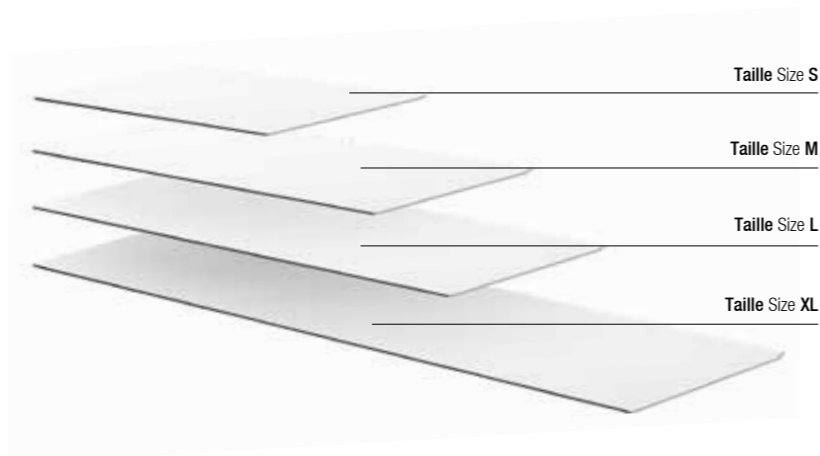

08
Tablette LINEAR LED, en aluminium, époxy blanc, et acrylique, polarwhite, inclus éclairage LED et aimants intégrés, disponible en 3 tailles.

LINEAR LED shelf, made of aluminium, white powder-coated and acrylic glass, polarwhite, including LED illumination and integrated magnets, available in 3 dimensions

Taille S (pour 1-2 supports produits)
Size S (for 1-2 product carriers)
350 x 7 x 200 mm L/14.18.06.00 **114,00 €**

Taille M (pour 2 supports produits)
Size M (for 2 product carriers)
500 x 7 x 200 mm L/14.18.07.00 **141,00 €**

Taille L (pour 3 supports produits)
Size L (for 3 product carriers)
600 x 7 x 200 mm L/14.18.08.00 **161,00 €**

Taille XL (pour 4 supports produits)
Size XL (for 4 product carriers)
825 x 7 x 200 mm L/14.18.09.00 **187,00 €**

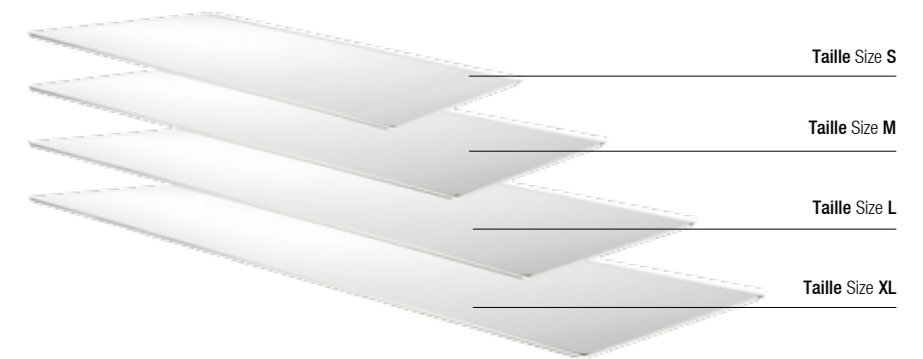

09
Support simple de lunettes LINEAR LED, acier nickelé, avec aimant
LINEAR LED single spectacle display, made of steel, nickel-plated, with magnet

dessus top
170 x 70 x 85 mm L/14.09.01.00 **16,00 €**



10
Support simple de lunettes LINEAR LED, en acier nickelé, avec aimant
LINEAR LED single spectacle display, made of steel, nickel-plated, with magnet

dessous bottom
170 x 77 x 85 mm L/14.09.01.04 **16,00 €**



11
Support double de lunettes LINEAR LED, acier nickelé, avec aimant
LINEAR LED double spectacle display, made of steel, nickel-plated, with magnet

dessus top
170 x 145 x 170 mm L/14.09.01.01 **26,00 €**

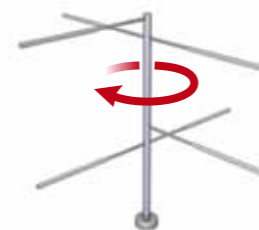

12
Support double de lunettes LINEAR LED, acier nickelé, avec aimant
LINEAR LED double spectacle display, made of steel, nickel-plated, with magnet

dessous bottom
170 x 147 x 85 mm L/14.09.02.01 **26,00 €**

