

01 MO W 70/14 STRIPE 02 MO W 87/14 STRIPE 03 MO W 10/14 STRIPE



Combinable avec élément de stockage
Can be combined with storage



04 MO W 70/21 STRIPE 05 MO W 87/21 STRIPE 06 MO W 10/21 STRIPE



STRIFE PANNEAUX MURAUX WALL PANELS

Nos tablettes STRIFE sont sublimes par leur design. Elles ont un éclairage LED intégré en partie basse, qui éclaire de manière optimale les produits placés en dessous et les met en valeur. Grâce à la finition satinée des tablettes, l'éclairage uniforme souligne le caractère structurel de la présentation et la mise en valeur optimale des produits.

Our STRIFE shelves appeal through an elegant design. They have a built-in LED light at the bottom which illuminates underlying objects perfectly and brings to bear. Thanks to the satin surface the merchandise is uniformly illuminated, which underlines the sculptural character of the presentation and displays the goods perfectly.

Mode opératoire:
Mode of operation:

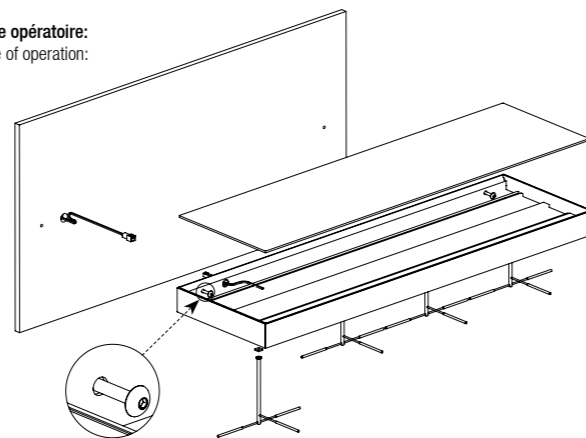

Panneaux en acrylique blanc mat, équipés avec tablettes STRIFE. Inclus structure MOSAIC.* Autres accessoires disponibles, veuillez commander séparément. Autres variantes disponibles sur demande.

Panels made of acrylic glass, matt white, fitted with STRIFE shelves. MOSAIC substructure included.* Additional accessories available, please order separately. Additional variants available on request.

01 MO W 70/14 STRIPE
695 x 1395 mm
MO.27.11.70.14.04

20
1.378,00 €

02 MO W 87/14 STRIPE
870 x 1395 mm
MO.27.11.87.14.04

25
1.649,00 €

03 MO W 10/14 STRIPE
1045 x 1395 mm
MO.27.11.10.14.04

30
1.919,00 €

04 MO W 70/21 STRIPE
695 x 2095 mm
MO.27.11.70.21.04

24
1.746,00 €

05 MO W 87/21 STRIPE
870 x 2095 mm
MO.27.11.87.21.04

30
2.093,00 €

06 MO W 10/21 STRIPE
1045 x 2095 mm
MO.27.11.10.21.04

36
2.441,00 €

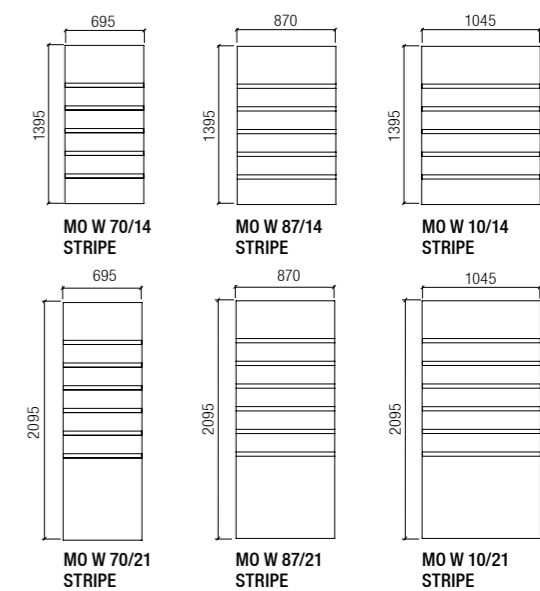



STRIPE SYSTEM

01
STRIPE tablette en aluminium, époxy blanc, en acrylique, dualsatin, inclus éclairage LED. Bandeau décoratif sur demande.
 STRIPE shelf, made of aluminium, white powder-coated, and acrylic glass, dualsatin, including LED illumination. Decorative covers on request.

Taille Size S
 695 x 40 x 208 mm L/14.19.07.00/02 **197,00 €**

Taille Size M
 870 x 40 x 208 mm L/14.19.09.00/02 **233,00 €**

Taille Size L
 1045 x 40 x 208 mm L/14.19.10.00/02 **269,00 €**

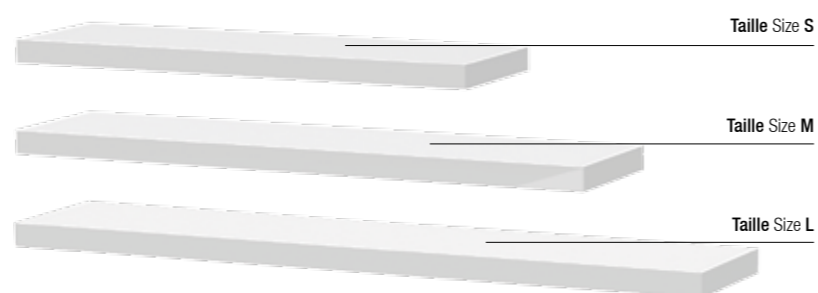

02
Support simple de lunettes, nickelé
 Single spectacle display, nickel-plated

dessous bottom
 170 x 110 x 84 mm L/14.18.01.12 **13,00 €**



Application
 Application

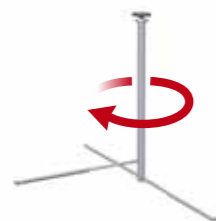

03
Support double de lunettes, nickelé
 Double spectacle display, nickel-plated

dessous bottom
 170 x 145 x 84 mm L/14.18.01.16 **20,00 €**

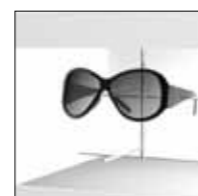

Application
 Application

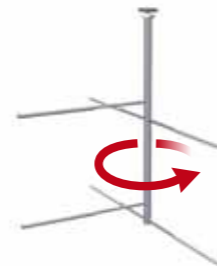

01
LINE UP, profilé en aluminium, anodisé argenté, découpé sur mesure, vendu au mètre
 LINE UP, aluminium profile, anodized silver, cut by measure, sold by metre

max. 6000 x 17 x 6 mm

19.50.00.00 **11,00 €**

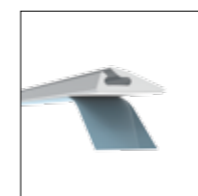

Film adhésif
 Self-adhesive foil



02
LINE UP, support de lunettes, acier inoxydable
 LINE UP, spectacle display, stainless steel

33 x 66 x 98 mm

19.50.01.00 **3,00 €**

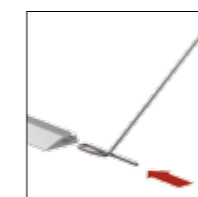

SYSTÈME LINE UP

Le système LINE UP assure une présentation ordonnée des produits sur vos étagères et sur vos surfaces de présentation! Le profil en aluminium filigrané peut être simplement collé à n'importe quelle surface lisse sur laquelle des lunettes doivent être présentées. Les supports peuvent être déplacés et positionnés progressivement dans le profilé. Cela rend LINE UP en particulier pour les présentations où les produits doivent avoir des places réservées.

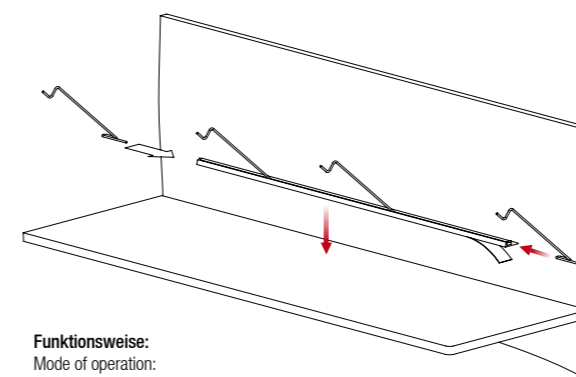

Funktionsweise:
 Mode of operation:

The LINE UP system ensures an orderly presentation of goods on your shelves and presentation surfaces! The filigree aluminium profile can simply be glued to any smooth surface on which eyewear should be presented. The supports can be positioned stepless within the profile. This makes LINE UP particularly suitable for all presentations where the products should be displayed on fixed spots.